

30V, 208A, 1.9mΩ N-channel Power SGT MOSFET
JMSL0302PG
Features

- Excellent $R_{DS(ON)}$ and Low Gate Charge
- 100% UIS Tested
- 100% ΔV_{ds} Tested
- Halogen-free; RoHS-compliant

Applications

- Load Switch
- PWM Application
- Power Management

Product Summary

Parameters	Value	Unit
V_{DSS}	30	V
$V_{GS(th)}_{Typ}$	1.6	V
$I_D(@V_{GS}=10V)$	208	A
$R_{DS(ON)}_{Typ}(@V_{GS}=10V)$	1.3	mΩ
$R_{DS(ON)}_{Typ}(@V_{GS}=4.5V)$	1.9	mΩ

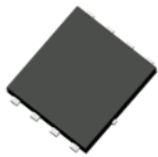

Top View

PDFN5x6-8L

Bottom View

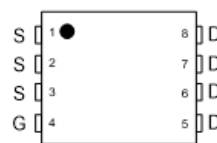
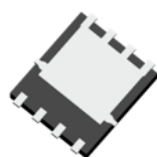
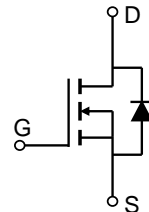
Pin Assignment

Schematic Diagram
Ordering Information

Device	Marking	MSL	Form	Package	Reel(pcs)	Per Carton (pcs)
JMSL0302PG-13	SL0302P	1	Tape&Reel	PDFN5x6-8L	5000	50000

Absolute Maximum Ratings (@ $T_C = 25^\circ\text{C}$ unless otherwise specified)

Symbol	Parameter	Value	Unit
V_{DS}	Drain-to-Source Voltage	30	V
V_{GS}	Gate-to-Source Voltage	± 20	V
I_D	Continuous Drain Current	$T_C = 25^\circ\text{C}$	208
		$T_C = 100^\circ\text{C}$	147
I_{DM}	Pulsed Drain Current ⁽¹⁾	Refer to Fig.4	A
E_{AS}	Single Pulsed Avalanche Energy ⁽²⁾	277	mJ
P_D	Power Dissipation	$T_C = 25^\circ\text{C}$	122
		$T_C = 100^\circ\text{C}$	49
T_J, T_{STG}	Junction & Storage Temperature Range	-55 to 150	$^\circ\text{C}$

Thermal Characteristics

Symbol	Parameter	Max	Unit
$R_{\theta JA}$	Thermal Resistance, Junction to Ambient ⁽³⁾	42	$^\circ\text{C}/\text{W}$
$R_{\theta JC}$	Thermal Resistance, Junction to Case	1.0	

**Electrical Characteristics** ($T_J = 25^\circ\text{C}$ unless otherwise specified)

Symbol	Parameter	Conditions	Min.	Typ.	Max.	Unit
Off Characteristics						
$V_{(BR)DSS}$	Drain-Source Breakdown Voltage	$I_D = 250\mu\text{A}$, $V_{GS} = 0\text{V}$	30	-	-	V
I_{DSS}	Zero Gate Voltage Drain Current	$V_{DS} = 24\text{V}$, $V_{GS} = 0\text{V}$	-	-	1.0	μA
I_{GSS}	Gate-Body Leakage Current	$V_{DS} = 0\text{V}$, $V_{GS} = \pm 20\text{V}$	-	-	± 100	nA
On Characteristics						
$V_{GS(th)}$	Gate Threshold Voltage	$V_{DS} = V_{GS}$, $I_D = 250\mu\text{A}$	1.1	1.6	2.1	V
$R_{DS(ON)}$	Static Drain-Source ON-Resistance ⁽⁴⁾	$V_{GS} = 10\text{V}$, $I_D = 20\text{A}$	-	1.3	1.8	m Ω
		$V_{GS} = 4.5\text{V}$, $I_D = 15\text{A}$	-	1.9	2.7	m Ω
Dynamic Characteristics						
R_g	Gate Resistance	$f = 1\text{MHz}$	-	1.1	-	Ω
C_{iss}	Input Capacitance	$V_{GS} = 0\text{V}$, $V_{DS} = 15\text{V}$, $f = 1\text{MHz}$	2312	3237	4369	pF
C_{oss}	Output Capacitance		1620	2268	3062	pF
C_{riss}	Reverse Transfer Capacitance		148	207	280	pF
Q_g	Total Gate Charge	$V_{GS} = 0$ to 10V $V_{DS} = 15\text{V}$, $I_D = 15\text{A}$	37	51	69	nC
Q_{gs}	Gate Source Charge		-	8.7	-	nC
Q_{gd}	Gate Drain("Miller") Charge		-	11	-	nC
Switching Characteristics						
$t_{d(on)}$	Turn-On DelayTime	$V_{GS} = 10\text{V}$, $V_{DD} = 15\text{V}$ $I_D = 15\text{A}$, $R_{GEN} = 6.2\Omega$	-	24	-	ns
t_r	Turn-On Rise Time		-	55	-	ns
$t_{d(off)}$	Turn-Off DelayTime		-	36	-	ns
t_f	Turn-Off Fall Time		-	35	-	ns
Body Diode Characteristics						
I_S	Maximum Continuous Body Diode Forward Current		-	-	208	A
I_{SM}	Maximum Pulsed Body Diode Forward Current		-	-	831	A
V_{SD}	Body Diode Forward Voltage	$V_{GS} = 0\text{V}$, $I_S = 20\text{A}$	-	-	1.2	V
t_{rr}	Body Diode Reverse Recovery Time	$I_F = 15\text{A}$, $di/dt = 100\text{A/us}$	-	56	-	ns
Q_{rr}	Body Diode Reverse Recovery Charge		-	62	-	nC

- Notes:
1. Repetitive Rating: Pulse Width Limited by Maximum Junction Temperature.
 2. E_{AS} condition: Starting $T_J = 25^\circ\text{C}$, $V_{DD} = 15\text{V}$, $V_{GS} = 10\text{V}$, $R_G = 25\text{ohm}$, $L = 3\text{mH}$, $I_{AS} = 13.58\text{A}$, $V_{DD} = 0\text{V}$ during time in avalanche.
 3. $R_{\theta JA}$ is measured with the device mounted on a 1inch^2 pad of 2oz copper FR4 PCB.
 4. Pulse Test: Pulse Width $\leq 300\mu\text{s}$, Duty Cycle $\leq 0.5\%$.



Typical Performance Characteristics

Figure 1: Power De-rating

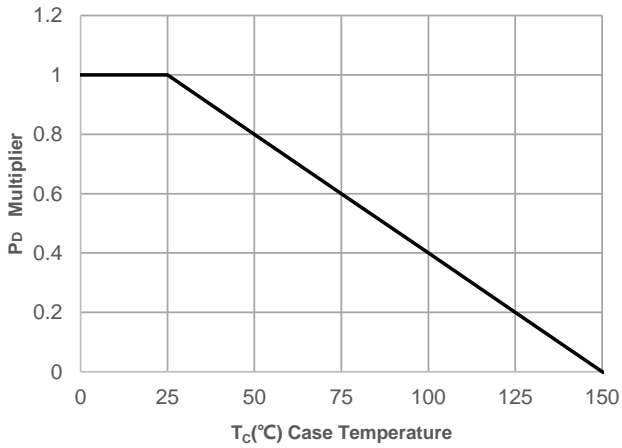

Figure 2: Current De-rating

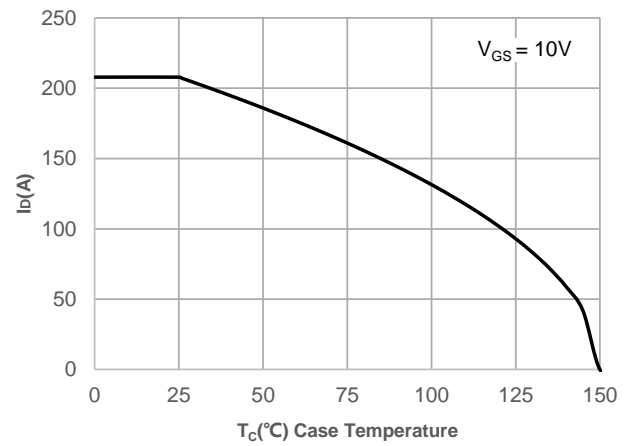

Figure 3: Normalized Maximum Transient Thermal Impedance

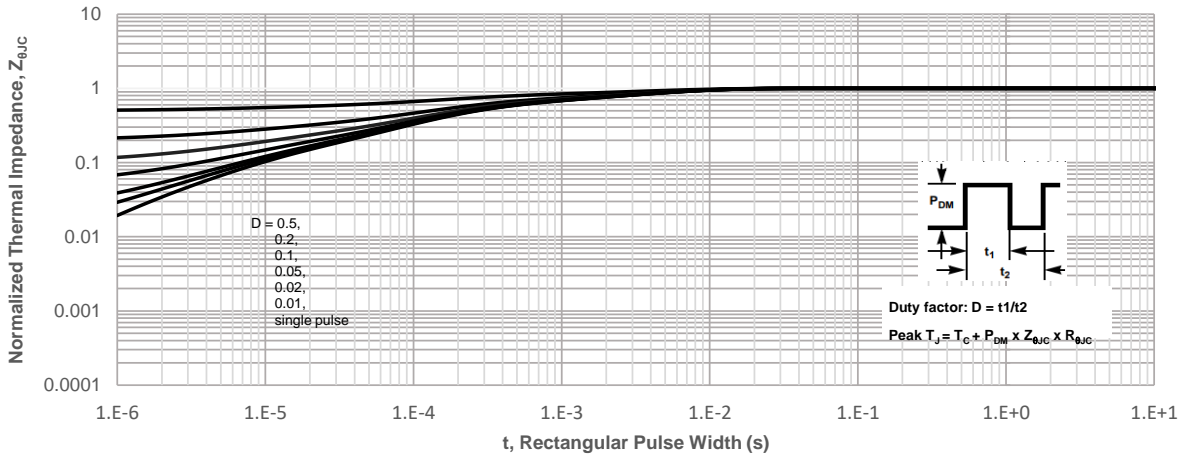
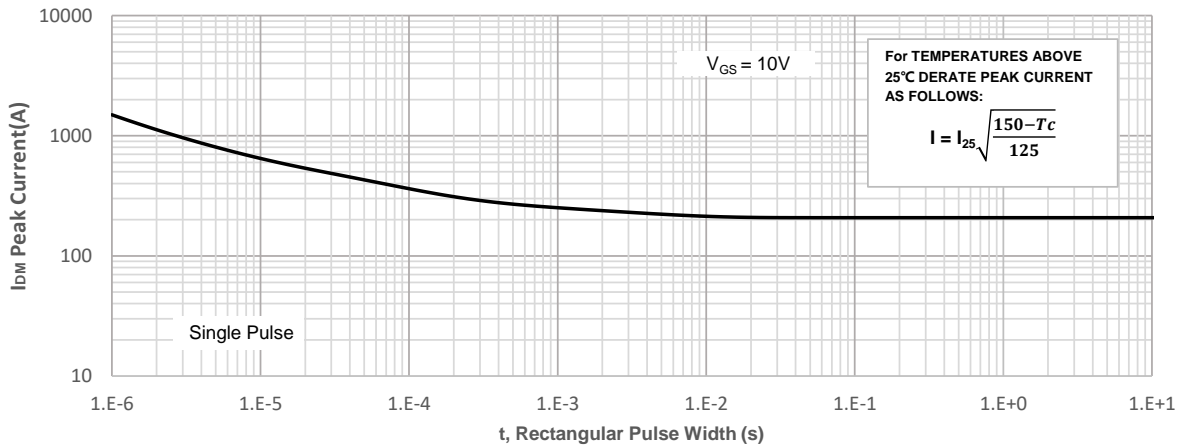

Figure 4: Peak Current Capacity



Typical Performance Characteristics

Figure 5: Output Characteristics

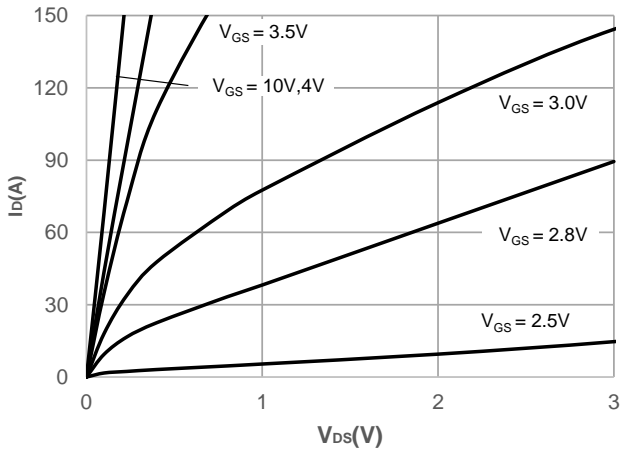

Figure 6: Typical Transfer Characteristics

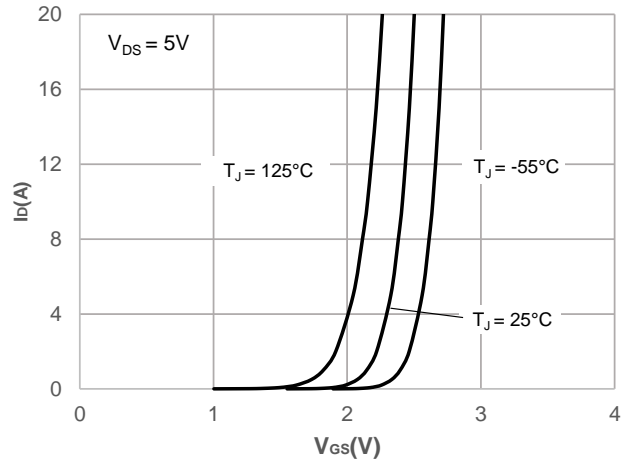

Figure 7: On-resistance vs. Drain Current

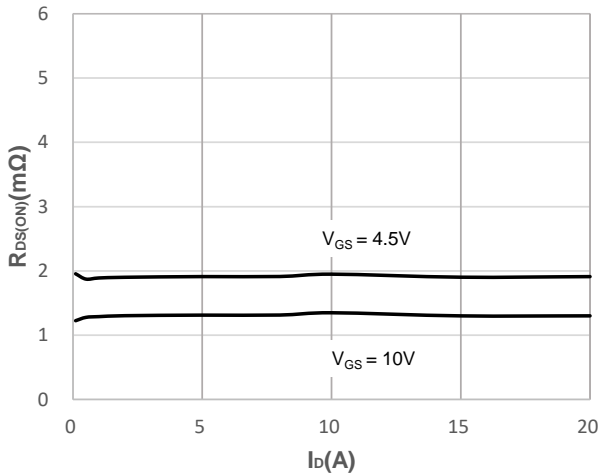

Figure 8: Body Diode Characteristics

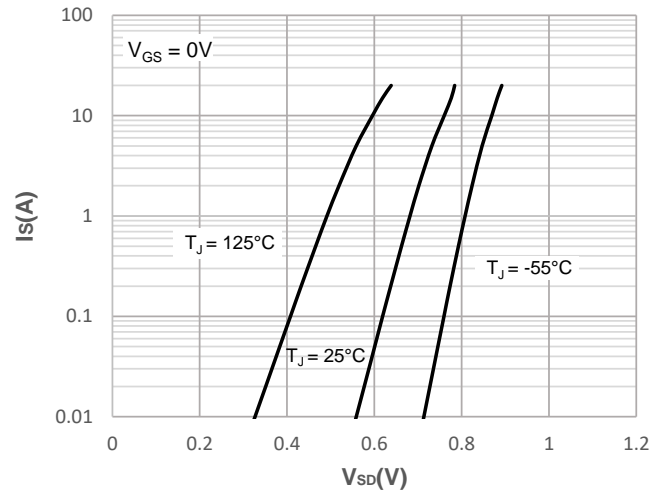

Figure 9: Gate Charge Characteristics

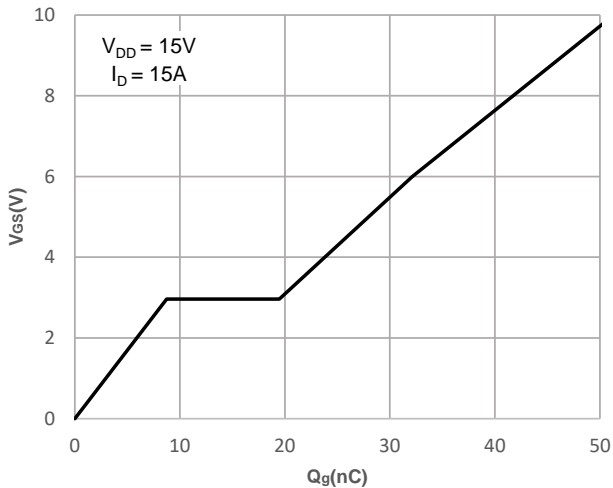
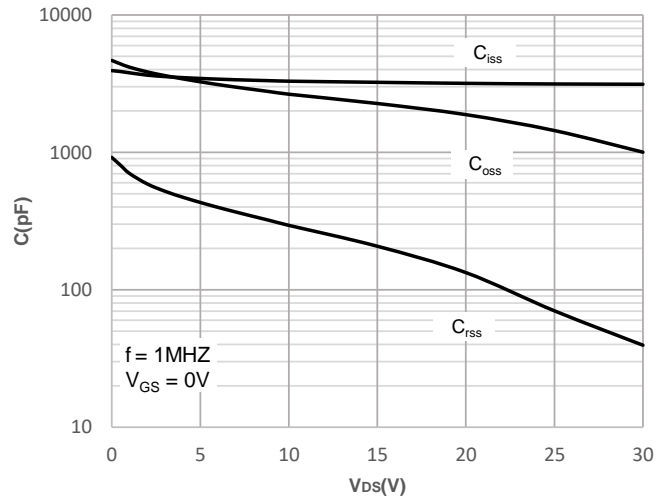

Figure 10: Capacitance Characteristics



Typical Performance Characteristics

Figure 11: Normalized Breakdown voltage vs. Junction Temperature

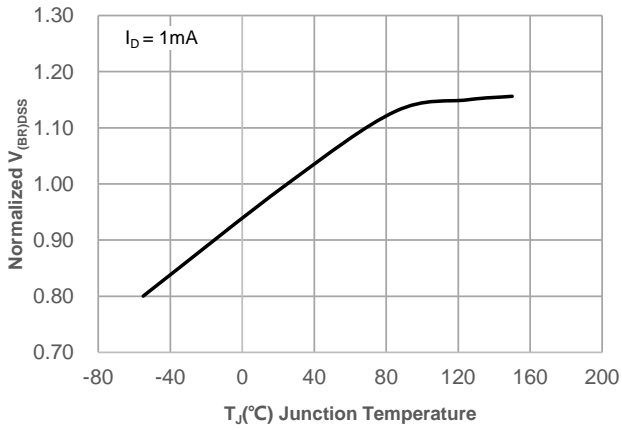

Figure 12: Normalized on Resistance vs. Junction Temperature

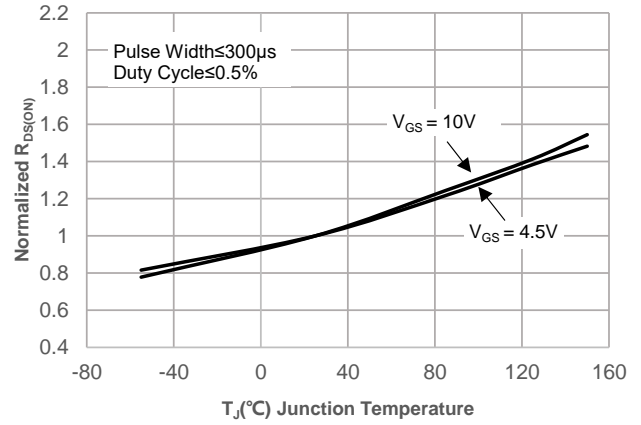

Figure 13: Normalized Threshold Voltage vs. Junction Temperature

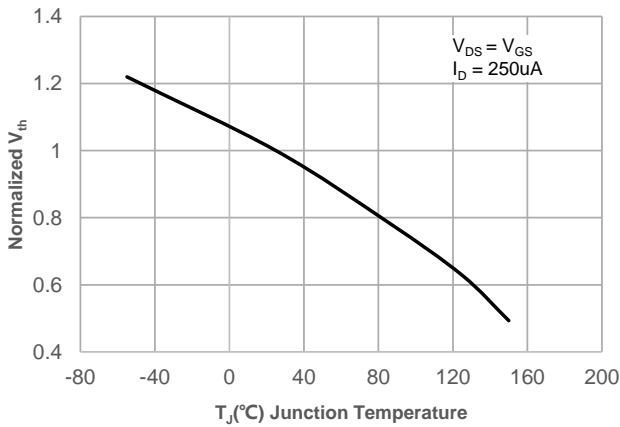

Figure 14: $R_{DS(ON)}$ vs. V_{GS}

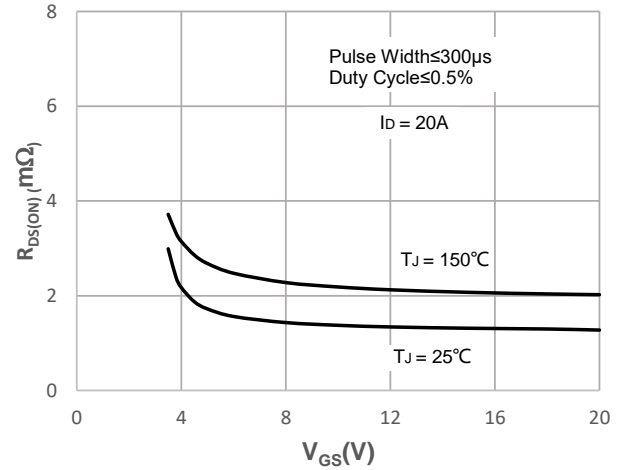
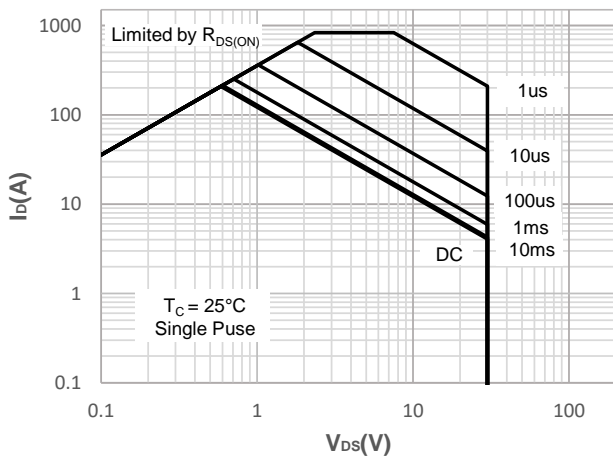

Figure 15: Maximum Safe Operating Area



Test Circuit

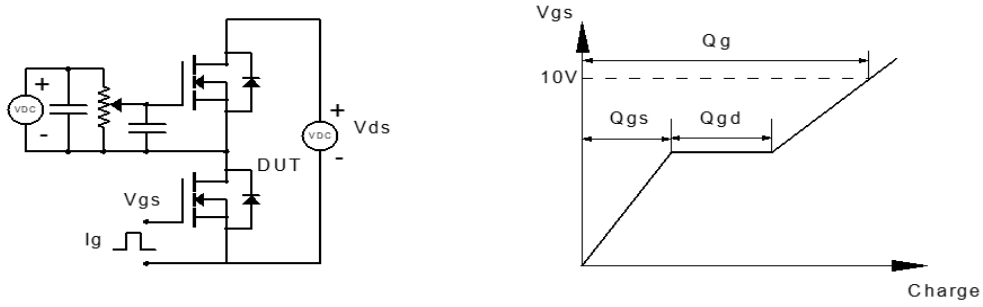

Figure 1: Gate Charge Test Circuit & Waveform

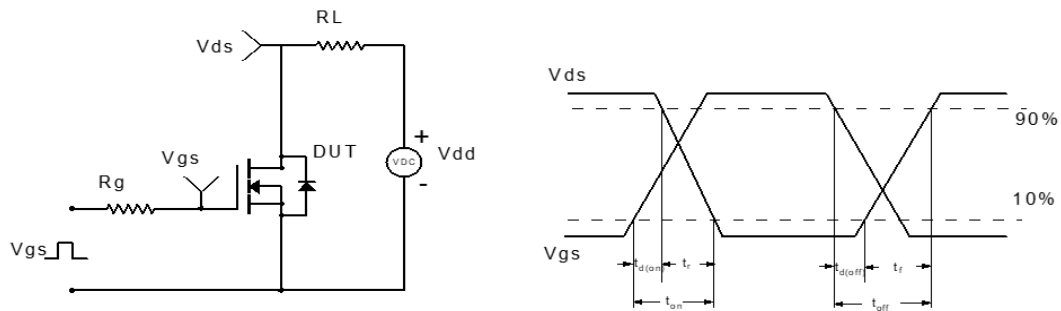

Figure 2: Resistive Switching Test Circuit & Waveform

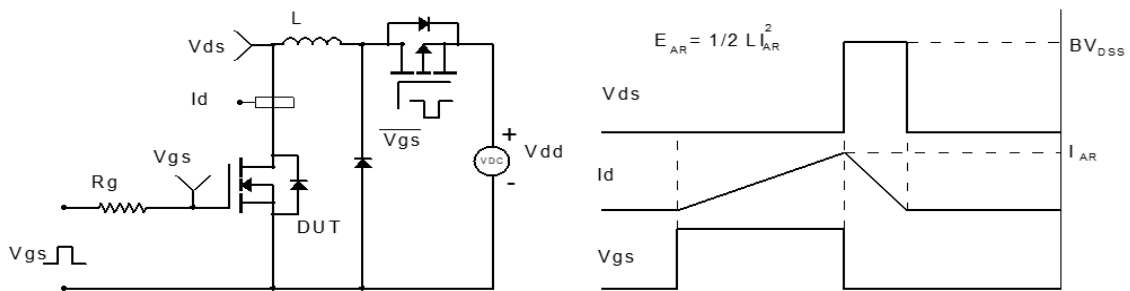

Figure 3: Unclamped Inductive Switching Test Circuit & Waveform

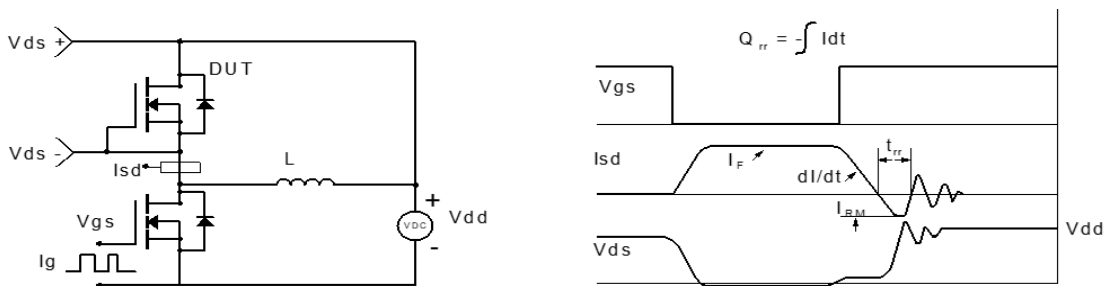
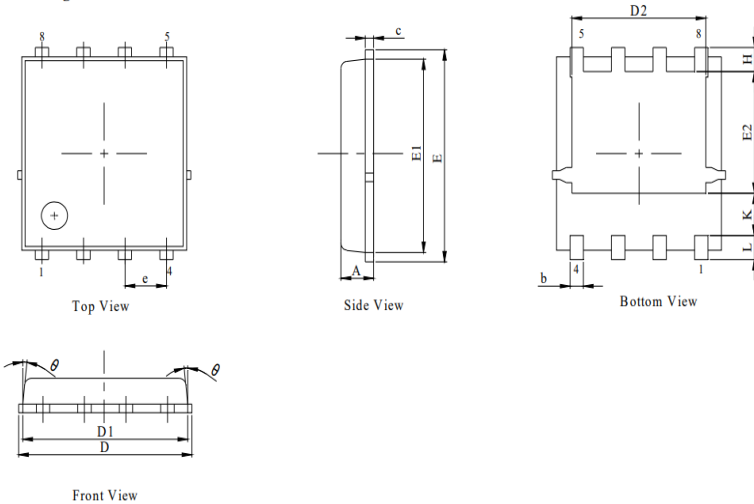

Figure 4: Diode Recovery Test Circuit & Waveform



Package Mechanical Data(PDFN5X6-8L)

Package Outline



DIM.	MILLIMETER		
	MIN.	NOM.	MAX.
A	0.9	1	1.15
b	0.31	0.41	0.51
C	0.24	0.32	0.4
D	5	5.2	5.4
D1	4.95	5.05	5.15
D2	4	4.1	4.2
E	6.05	6.15	6.25
E1	5.5	5.6	5.7
E2	3.42	3.53	3.63
e	1.27BSC		
H	0.6	0.7	0.8
L	0.5	0.7	0.8
K	1.23 REF		
0			10

NOTES:

1. Dimension and tolerance per ASME Y14.5M, 1994.
2. All dimensions in millimeter (angle in degree).
3. Dimensions D1 and E1 do not include mold flash protrusions or gate burrs.

Recommended Soldering Footprint

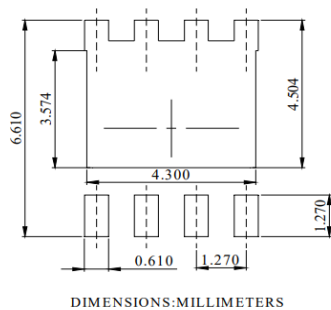

Information furnished in this document is believed to be accurate and reliable. However, Jiangsu JieJie Microelectronics Co.,Ltd assumes no responsibility for the consequences of use without consideration for such information nor use beyond it. Information mentioned in this document is subject to change without notice, apart from that when an agreement is signed, Jiangsu JieJie complies with the agreement. Products and information provided in this document have no infringement of patents. Jiangsu JieJie assumes no responsibility for any infringement of other rights of third parties which may result from the use of such products and information.

is a registered trademark of Jiangsu JieJie Microelectronics Co.,Ltd.