

Key performance:

- $V_{CE}=1200V$
- $I_C=15A@T_C=100^{\circ}C$
- $V_{CE(sat)}=1.75V$

Features:

- Low V_{CEsat} .
- Low switching losses
- Low stray inductance design
- Positive V_{CEsat} temperature coefficient
- 10us short circuits capability

Benefits:

- High efficiency for application
- Convenient for mounting
- RoHS compliant.

Applications:

- Motor drives
- Servo drives
- Auxiliary inverters

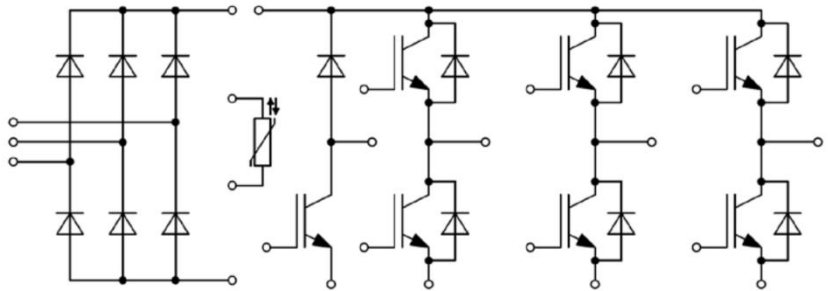
Typical Appearance:**Equivalent Circuit Schematic:**

IGBT, Inverter Maximum rated values

Parameter	Conditions	Symbol	Values	Unit
Collector-emitter voltage	$T_{vj} = 25^{\circ}\text{C}$	V_{CES}	1200	V
Continuous collector current	$T_C = 100^{\circ}\text{C}, T_{vj\text{ max}} = 175^{\circ}\text{C}$	I_C	15	A
Repetitive peak collector current	$t_p = 1\text{ ms}$	I_{CRM}	30	A
Total power dissipation	$T_C = 25^{\circ}\text{C}, T_{vj\text{ max}} = 175^{\circ}\text{C}$	P_{tot}	132	W
Gate-emitter peak voltage		V_{GES}	± 20	V

Characteristic values

Parameter	Conditions	Symbol	Values			Unit
			Min.	Typ.	Max.	
Collector-emitter saturation voltage	$I_C = 15\text{A}, V_{GE} = 15\text{ V}$ $T_{vj} = 25^{\circ}\text{C}$ $I_C = 15\text{A}, V_{GE} = 15\text{ V}$ $T_{vj} = 125^{\circ}\text{C}$ $I_C = 15\text{A}, V_{GE} = 15\text{ V}$ $T_{vj} = 150^{\circ}\text{C}$	V_{CESat}	-	1.75 2.10 2.15	-	V
Gate threshold voltage	$I_C = 1\text{ mA}, V_{CE} = V_{GE}, T_{vj} = 25^{\circ}\text{C}$	V_{GEth}	-	6.2	-	V
Gate charge	$V_{GE} = -15 / 15\text{ V}$	Q_G	-	0.15	-	μC
Input capacitance	$f = 1\text{ MHz}, T_{vj} = 25^{\circ}\text{C},$	C_{ies}	-	1.29	-	nF
Reverse transfer capacitance	$V_{CE} = 25\text{ V}, V_{GE} = 0\text{ V}$	C_{res}	-	13.5	-	pF
Collector-emitter leakage current	$V_{CE} = 1200\text{ V}, V_{GE} = 0\text{ V},$ $T_{vj} = 25^{\circ}\text{C}$	I_{CES}	-	-	1.0	mA
Gate-emitter leakage current	$V_{CE} = 0\text{ V}, V_{GE} = 20\text{ V},$ $T_{vj} = 25^{\circ}\text{C}$	I_{GES}	-	-	500	nA
Turn-on delay time, inductive load	$I_C = 15\text{A}, V_{CE} = 600\text{ V}$ $T_{vj} = 25^{\circ}\text{C}$ $V_{GE} = -15 / 15\text{ V}$ $T_{vj} = 125^{\circ}\text{C}$ $R_G = 5.1\Omega$ $T_{vj} = 150^{\circ}\text{C}$	$t_{d(on)}$	-	10.2 12.8 10.6	-	ns
Rise time, inductive load	$I_C = 15\text{A}, V_{CE} = 600\text{ V}$ $T_{vj} = 25^{\circ}\text{C}$ $V_{GE} = -15 / 15\text{ V}$, $T_{vj} = 125^{\circ}\text{C}$ $R_G = 5.1\Omega$ $T_{vj} = 150^{\circ}\text{C}$	t_r	-	21.0 20.5 22.4	-	ns
Turn-off delay time, inductive load	$I_C = 15\text{A}, V_{CE} = 600\text{ V}$ $T_{vj} = 25^{\circ}\text{C}$ $V_{GE} = -15 / 15\text{ V}$ $T_{vj} = 125^{\circ}\text{C}$ $R_G = 5.1\Omega$ $T_{vj} = 150^{\circ}\text{C}$	$t_{d(off)}$	-	152 176 191	-	ns
Fall time, inductive load	$I_C = 15\text{A}, V_{CE} = 600\text{ V}$ $T_{vj} = 25^{\circ}\text{C}$ $V_{GE} = -15 / 15\text{ V}$ $T_{vj} = 125^{\circ}\text{C}$ $R_G = 5.1\Omega$ $T_{vj} = 150^{\circ}\text{C}$	t_f	-	97 137 142	-	ns

Characteristic values

Turn-on energy loss per pulse	$I_C = 15\text{A}, V_{CE} = 600\text{V}$ $V_{GE} = -15 / 15\text{V}$ $R_G = 5.1\Omega$	$T_{vj} = 25^\circ\text{C}$ $T_{vj} = 125^\circ\text{C}$ $T_{vj} = 150^\circ\text{C}$	E_{on}	-	0.90 1.50 1.70	-	mJ
Turn-off energy loss per pulse	$I_C = 15\text{A}, V_{CE} = 600\text{V}$ $V_{GE} = -15 / 15\text{V}$ $R_G = 5.1\Omega$	$T_{vj} = 25^\circ\text{C}$ $T_{vj} = 125^\circ\text{C}$ $T_{vj} = 150^\circ\text{C}$	E_{off}	-	0.65 0.95 1.00	-	mJ
SC data	$V_{GE} \leq 15\text{V}, V_{CC} = 800\text{V}$ $t_P \leq 10\ \mu\text{s}, T_{vj} = 25^\circ\text{C}$		I_{SC}	-	66	-	A
Thermal resistance, junction to case	per IGBT		R_{thJC}	-	-	1.14	K/W
Thermal resistance, case to heatsink	per IGBT		R_{thCH}	-	1.02	-	K/W
Temperature under switching conditions			$T_{vj\ op}$	-40	-	150	$^\circ\text{C}$

Diode, Inverter
Maximum rated values

Parameter	Conditions	Symbol	Values	Unit
Repetitive peak reverse voltage	$T_{vj} = 25^\circ\text{C}$	V_{RRM}	1200	V
Continuous DC forward current		I_F	15	A
Repetitive peak forward current	$t_P = 1\text{ms}$	I_{FRM}	30	A

Characteristic values

Parameter	Conditions	Symbol	Values			Unit
			Min.	Typ.	Max.	
Forward voltage	$I_F = 15\text{A}, V_{GE} = 0\text{V}$	$T_{vj} = 25^\circ\text{C}$		1.90		V
	$I_F = 15\text{A}, V_{GE} = 0\text{V}$	$T_{vj} = 125^\circ\text{C}$	-	1.62	-	
	$I_F = 15\text{A}, V_{GE} = 0\text{V}$	$T_{vj} = 150^\circ\text{C}$		1.56		
Peak reverse recovery current	$I_F = 15\text{A}, V_R = 600\text{V}$	$T_{vj} = 25^\circ\text{C}$		11.8		A
	$V_{GE} = -15\text{V}$	$T_{vj} = 125^\circ\text{C}$	-	15.9	-	
	$-d_{iF}/d_t = 750\text{A}/\mu\text{s}$	$T_{vj} = 150^\circ\text{C}$		17.4		
Recovered charge	$I_F = 15\text{A}, V_R = 600\text{V}$	$T_{vj} = 25^\circ\text{C}$		0.99		μC
	$V_{GE} = -15\text{V}$	$T_{vj} = 125^\circ\text{C}$	-	2.16	-	
	$-d_{iF}/d_t = 750\text{A}/\mu\text{s}$	$T_{vj} = 150^\circ\text{C}$		2.80		
Reverse recovery energy	$I_F = 15\text{A}, V_R = 600\text{V}$	$T_{vj} = 25^\circ\text{C}$		0.33		mJ
	$V_{GE} = -15\text{V}$	$T_{vj} = 125^\circ\text{C}$	-	0.71	-	
	$-d_{iF}/d_t = 750\text{A}/\mu\text{s}$	$T_{vj} = 150^\circ\text{C}$		0.94		
Thermal resistance, junction to case	per diode	R_{thJC}	-	-	1.8	K/W
Thermal resistance, case to heatsink	per diode	R_{thCH}	-	1.2	-	K/W
Temperature under switching conditions		$T_{vj\ op}$	-40	-	150	$^\circ\text{C}$

**IGBT, Brake-Chopper
Maximum rated values**

Parameter	Conditions	Symbol	Values	Unit
Collector-emitter voltage	$T_{vj} = 25^{\circ}\text{C}$	V_{CES}	1200	V
Continuous collector current	$T_C = 100^{\circ}\text{C}, T_{vj\text{ max}} = 175^{\circ}\text{C}$	I_C	15	A
Repetitive peak collector current	$t_p = 1\text{ ms}$	I_{CRM}	30	A
Total power dissipation	$T_C = 25^{\circ}\text{C}, T_{vj\text{ max}} = 175^{\circ}\text{C}$	P_{tot}	132	W
Gate-emitter peak voltage		V_{GES}	± 20	V

Characteristic values

Parameter	Conditions	Symbol	Values			Unit
			Min.	Typ.	Max.	
Collector-emitter saturation voltage	$I_C = 15\text{A}, V_{GE} = 15\text{ V}$ $T_{vj} = 25^{\circ}\text{C}$	V_{CESat}	-	1.75	-	V
	$I_C = 15\text{A}, V_{GE} = 15\text{ V}$ $T_{vj} = 125^{\circ}\text{C}$		-	2.10	-	
	$I_C = 15\text{A}, V_{GE} = 15\text{ V}$ $T_{vj} = 150^{\circ}\text{C}$		-	2.15	-	
Gate threshold voltage	$I_C = 1\text{ mA}, V_{CE} = V_{GE}, T_{vj} = 25^{\circ}\text{C}$	V_{Geth}	-	6.2	-	V
Gate charge	$V_{GE} = -15 / 15\text{ V}$	Q_G	-	0.15	-	μC
Input capacitance	$f = 1\text{ MHz}, T_{vj} = 25^{\circ}\text{C},$ $V_{CE} = 25\text{ V}, V_{GE} = 0\text{ V}$	C_{ies}	-	1.29	-	nF
Reverse transfer capacitance		C_{res}	-	13.5	-	nF
Collector-emitter leakage current	$V_{CE} = 1200\text{ V}, V_{GE} = 0\text{ V},$ $T_{vj} = 25^{\circ}\text{C}$	I_{CES}	-	-	1.0	mA
Gate-emitter leakage current	$V_{CE} = 0\text{ V}, V_{GE} = 20\text{ V},$ $T_{vj} = 25^{\circ}\text{C}$	I_{GES}	-	-	500	nA
Turn-on delay time, inductive load	$I_C = 15\text{A}, V_{CE} = 600\text{ V}$ $T_{vj} = 25^{\circ}\text{C}$	$t_{d(on)}$	-	10.2	-	ns
	$V_{GE} = -15 / 15\text{ V}$ $T_{vj} = 125^{\circ}\text{C}$		-	10.5	-	
	$R_G = 5.1\Omega$ $T_{vj} = 150^{\circ}\text{C}$		-	10.6	-	
Rise time, inductive load	$I_C = 15\text{A}, V_{CE} = 600\text{ V}$ $T_{vj} = 25^{\circ}\text{C}$	t_r	-	21.0	-	ns
	$V_{GE} = -15 / 15\text{ V}$ $T_{vj} = 125^{\circ}\text{C}$		-	21.5	-	
	$R_G = 5.1\Omega$ $T_{vj} = 150^{\circ}\text{C}$		-	22.4	-	
Turn-off delay time, inductive load	$I_C = 15\text{A}, V_{CE} = 600\text{ V}$ $T_{vj} = 25^{\circ}\text{C}$	$t_{d(off)}$	-	152	-	ns
	$V_{GE} = -15 / 15\text{ V}$ $T_{vj} = 125^{\circ}\text{C}$		-	176	-	
	$R_G = 5.1\Omega$ $T_{vj} = 150^{\circ}\text{C}$		-	191	-	
Fall time, inductive load	$I_C = 15\text{A}, V_{CE} = 600\text{ V}$ $T_{vj} = 25^{\circ}\text{C}$	t_f	-	97	-	ns
	$V_{GE} = -15 / 15\text{ V}$ $T_{vj} = 125^{\circ}\text{C}$		-	137	-	
	$R_G = 5.1\Omega$ $T_{vj} = 150^{\circ}\text{C}$		-	142	-	

Characteristic values

Turn-on energy loss per pulse	$I_C = 15A, V_{CE} = 600V$ $V_{GE} = -15 / 15V$ $R_G = 5.1\Omega$	$T_{vj} = 25^\circ C$ $T_{vj} = 125^\circ C$ $T_{vj} = 150^\circ C$	E_{on}	-	0.90 1.50 1.70	-	mJ
Turn-off energy loss per pulse	$I_C = 15A, V_{CE} = 600V$ $V_{GE} = -15 / 15V$ $R_G = 5.1\Omega$	$T_{vj} = 25^\circ C$ $T_{vj} = 125^\circ C$ $T_{vj} = 150^\circ C$	E_{off}	-	0.65 0.95 1.00	-	mJ
SC data	$V_{GE} \leq 15V, V_{CC} = 800V$ $t_P \leq 10\mu s, T_{vj} = 25^\circ C$		I_{SC}	-	66	-	A
Thermal resistance, junction to case	per IGBT		R_{thJC}	-	-	1.14	K/W
Thermal resistance, case to heatsink	per IGBT		R_{thCH}	-	1.02	-	K/W
Temperature under switching conditions			$T_{vj op}$	-40	-	150	$^\circ C$

**Diode, Brake-Chopper
Maximum rated values**

Parameter	Conditions	Symbol	Values	Unit
Repetitive peak reverse voltage	$T_{vj} = 25^\circ C$	V_{RRM}	1200	V
Continuous DC forward current		I_F	10	A
Repetitive peak forward current	$t_P = 1ms$	I_{FRM}	20	A

Characteristic values

Parameter	Conditions	Symbol	Values			Unit
			Min.	Typ.	Max.	
Forward voltage	$I_F = 10A, V_{GE} = 0V$	$T_{vj} = 25^\circ C$		1.60		V
	$I_F = 10A, V_{GE} = 0V$	$T_{vj} = 125^\circ C$	-	1.35	-	
	$I_F = 10A, V_{GE} = 0V$	$T_{vj} = 150^\circ C$		1.25		
Peak reverse recovery current	$I_F = 10A, V_R = 600V$	$T_{vj} = 25^\circ C$		17.5		A
	$V_{GE} = -15V$	$T_{vj} = 125^\circ C$	-	21.0	-	
	$-d_{iF}/d_t = 750A/\mu s$	$T_{vj} = 150^\circ C$		22.3		
Recovered charge	$I_F = 10A, V_R = 600V$	$T_{vj} = 25^\circ C$		1.05		μC
	$V_{GE} = -15V$	$T_{vj} = 125^\circ C$	-	1.85	-	
	$-d_{iF}/d_t = 750A/\mu s$	$T_{vj} = 150^\circ C$		2.06		
Reverse recovery energy	$I_F = 10A, V_R = 600V$	$T_{vj} = 25^\circ C$		0.43		mJ
	$V_{GE} = -15V$	$T_{vj} = 125^\circ C$	-	0.58	-	
	$-d_{iF}/d_t = 750A/\mu s$	$T_{vj} = 150^\circ C$		0.82		
Thermal resistance, junction to case	per diode	R_{thJC}	-	1.20	1.40	K/W
Thermal resistance, case to heatsink	per diode	R_{thCH}	-	1.15	-	K/W
Temperature under switching conditions		$T_{vj op}$	-40		150	$^\circ C$

Diode, Rectifier

Maximum rated values

Parameter	Conditions	Symbol	Values	Unit
Repetitive peak reverse voltage	$T_{vj} = 25^{\circ}\text{C}$	V_{RRM}	1600	V
Maximum RMS current at rectifier output	$T_c = 100^{\circ}\text{C}$	I_F	30	A
Surge forward current	$t_p = 10 \text{ ms}, T_{vj} = 25^{\circ}\text{C}$	I_{FSM}	300	A
I^2t - value	$t_p = 10 \text{ ms}, T_{vj} = 25^{\circ}\text{C}$	I^2t	450	A^2s

Characteristic values

Parameter	Conditions	Symbol	Values			Unit
			Min.	Typ.	Max.	
Forward voltage	$I_F = 15 \text{ A}, T_{vj} = 150^{\circ}\text{C}$	V_F	-	0.98	-	V
Reverse recovery energy	$V_R = 1600 \text{ V}, T_{vj} = 150^{\circ}\text{C}$	I_R	-	-	1.0	mA
Thermal resistance, junction to case	per diode	R_{thJC}	-	1.23	1.4	K/W
Thermal resistance, case to heatsink	per diode	R_{thCH}	-	1.10	-	K/W
Temperature under switching conditions		$T_{vj \text{ op}}$	-40	-	150	$^{\circ}\text{C}$

NTC, Thermistor

Characteristic values

Parameter	Conditions	Symbol	Values			Unit
			Min.	Typ.	Max.	
Rated resistance	$T_{NTC} = 25^{\circ}\text{C}$	R_{25}	-	5	-	$\text{k}\Omega$
Deviation of R_{100}	$T_{NTC} = 100^{\circ}\text{C}, R_{100} = 493 \Omega$	$\Delta R/R$	-5	-	5	%
Power dissipation	$T_{NTC} = 25^{\circ}\text{C}$	P_{25}	-	-	20	mW

Module characteristic values

Parameter	Conditions	Symbol	Values	Unit
Isolation test voltage	RMS, f = 50 Hz, t = 1 min.	V _{ISOL}	2.5	kV
Internal isolation	basic insulation (class 1, IEC 61140)		Al ₂ O ₃	
Creepage distance	terminal to heatsink		11.5	mm
	terminal to terminal		6.3	
Clearance	terminal to heatsink		10	mm
	terminal to terminal		5	
Comperative tracking index		CTI	>200	

Parameter	Conditions	Symbol	Values	Unit
Isolation test voltage	RMS, f = 50 Hz, t = 1 min.	V _{ISOL}	2.5	kV
Internal isolation	basic insulation (class 1, IEC 61140)		Al ₂ O ₃	
Creepage distance	terminal to heatsink		11.5	mm
	terminal to terminal		6.3	
Clearance	terminal to heatsink		10	mm
	terminal to terminal		5	
Comperative tracking index		CTI	>200	

Output characteristic, IGBT

$$I_c = f(V_{CE})$$

$$V_{GE} = 15V$$

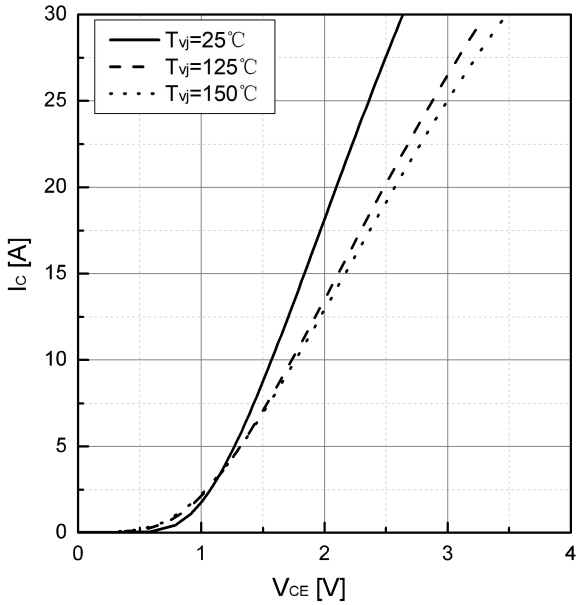
Output characteristic, IGBT

$$I_c = f(V_{CE})$$

$$T_{vj} = 150^\circ C$$

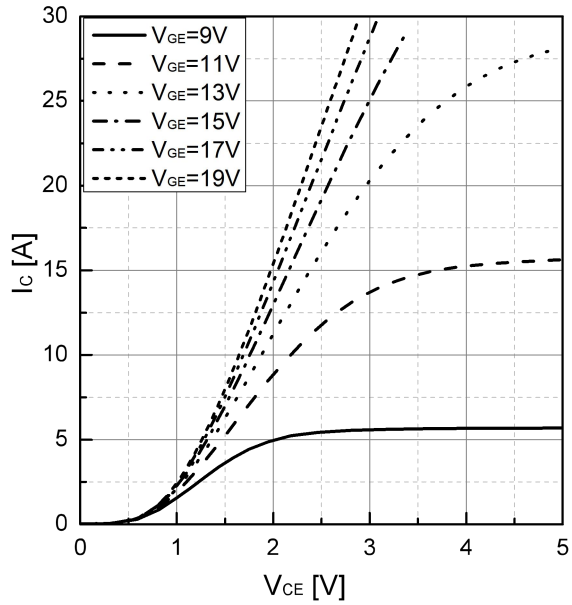
Transfer characteristic, IGBT

$$I_c = f(V_{GE})$$

$$V_{CE} = 20V$$

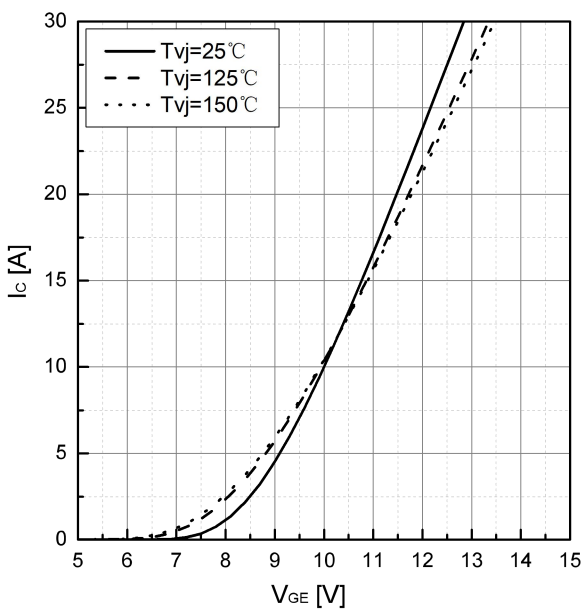
Switching losses vs. I_c, IGBT

$$E_{on} = f(I_c), E_{off} = f(I_c)$$

$$V_{CE} = 600V, V_{GE} = 15/-15V, R_G = 5.1 \Omega$$

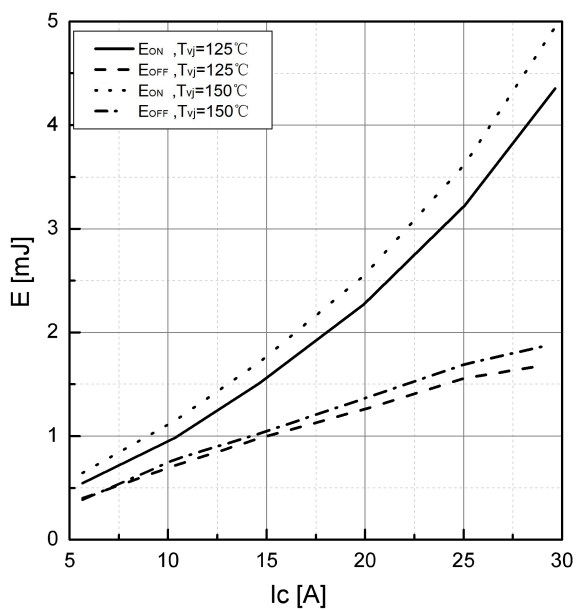

Switching losses vs. R_G , IGBT

$$E_{on}=f(R_G), E_{off}=f(R_G)$$

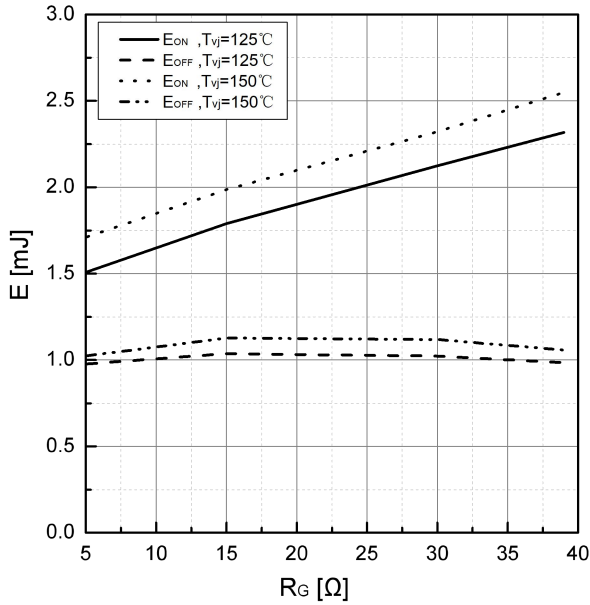
 $V_{CE}=600V, V_{GE}=15/-15V, I_C=15A$

Capacity characteristic, IGBT

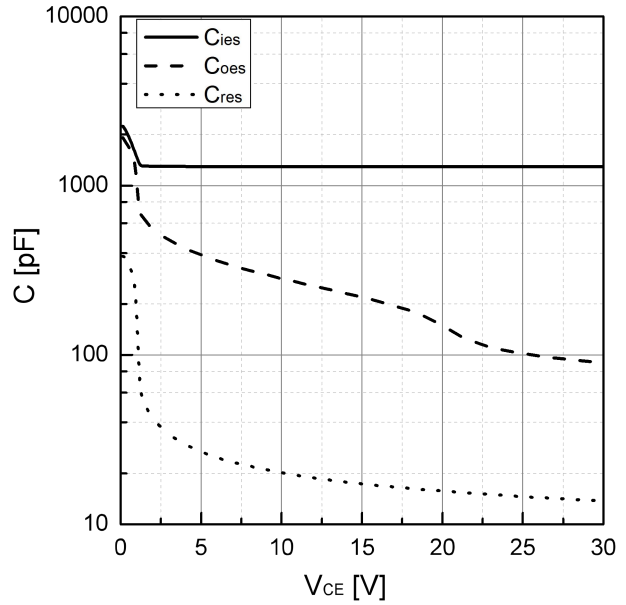
$$C=f(V_{CE})$$

 $f=100KHz, V_{GE}=0V, T_{vj}=25^{\circ}C$

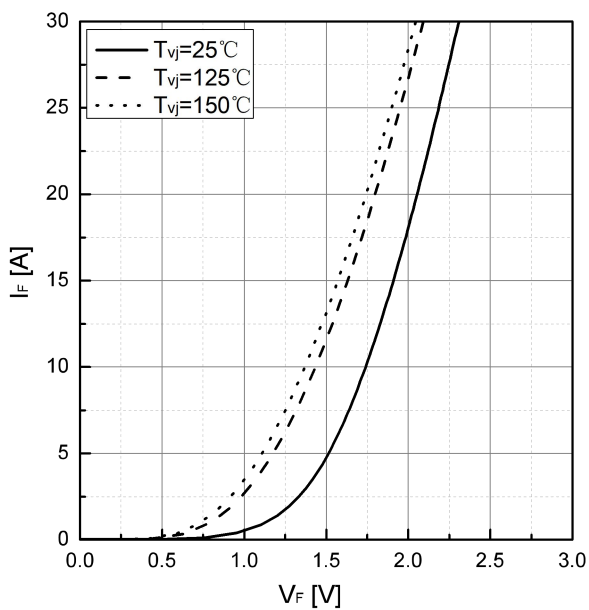
Forward characteristic, Diode

$$I_F=f(V_F)$$

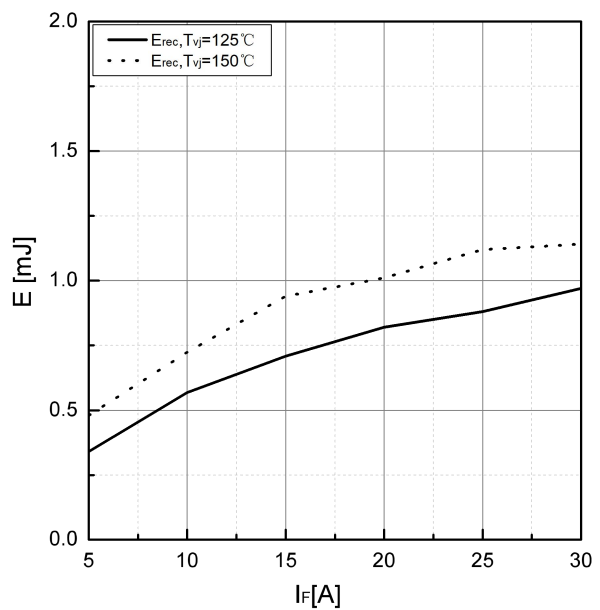

Switching losses vs. I_F , Diode

$$E_{rec}=f(I_F)$$

 $V_R=600V, R_G=5.1 \Omega$

Switching losses vs. R_G , Diode

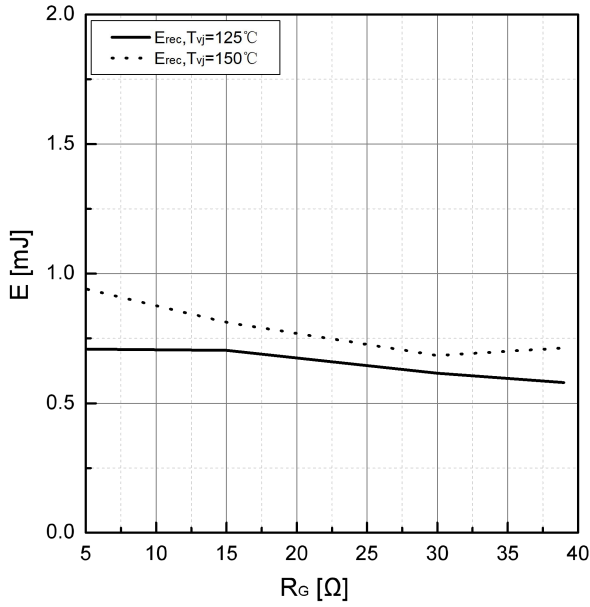
$E_{rec}=f(R_G)$
 $V_R=600V, I_F=15A$



Reverse bias safe operating area (RBSOA)

$V_{CE}=600V, V_{GE}=15/-15V, R_G=5.1 \Omega$

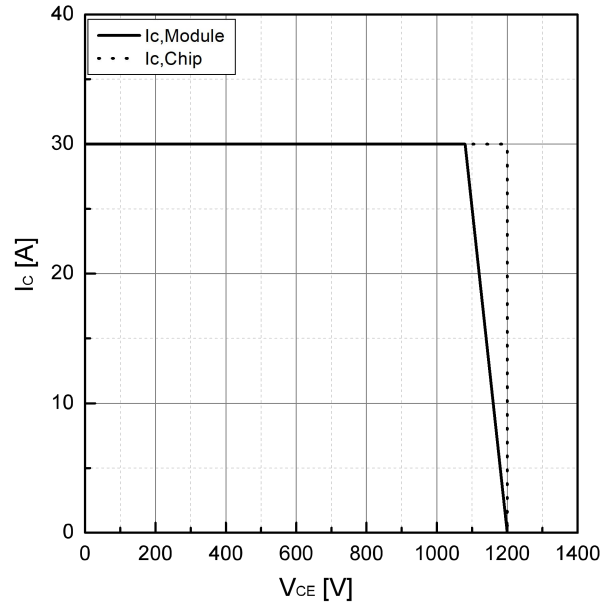

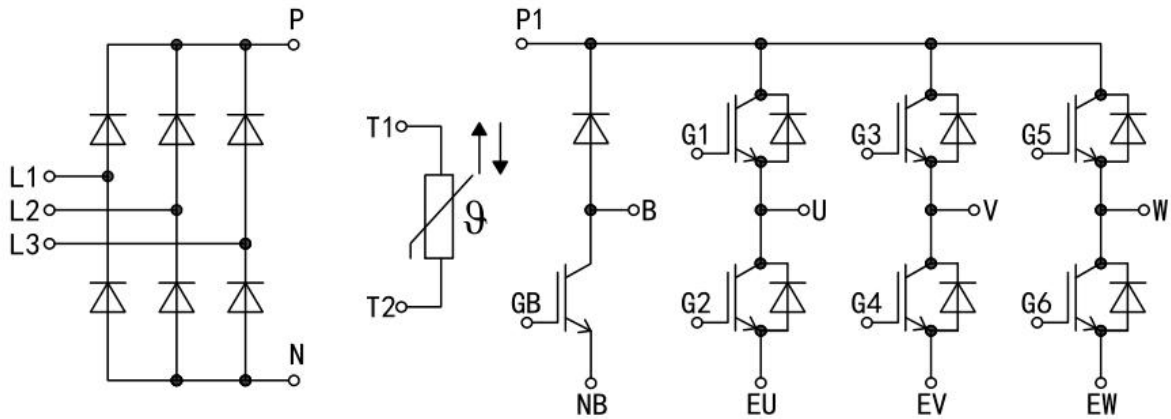
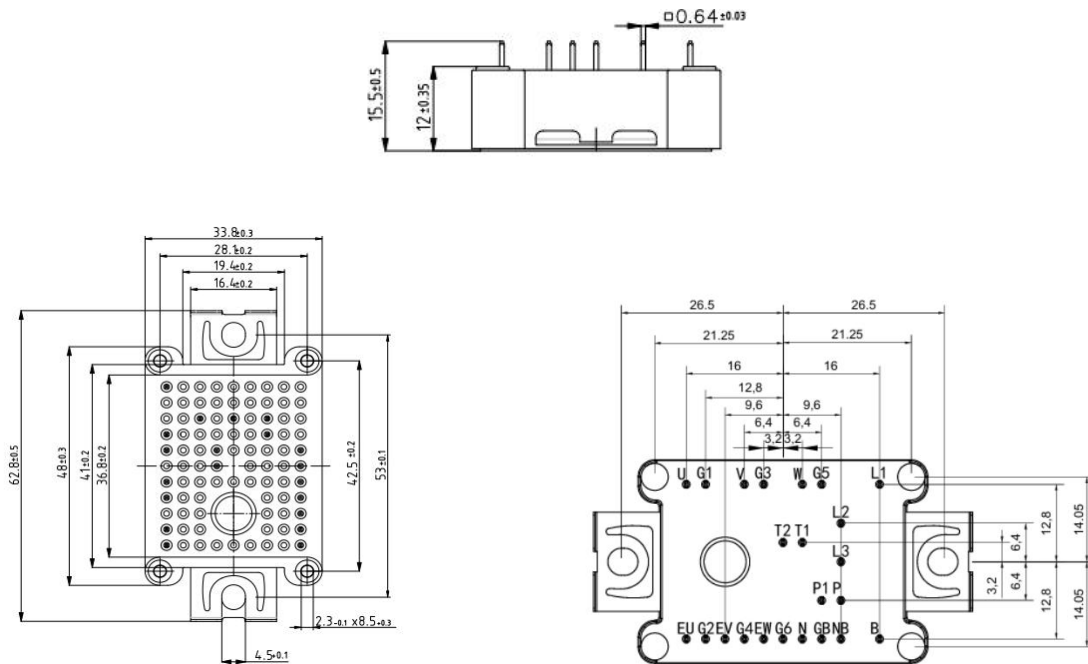
Circuit diagram

Package outlines (mm)

Revision history

Date	Revision	Changes
Sep 17, 2024	Rev 1.0	Release of the final datasheet.

Disclaimer

PLEASE NOTE - Jiangsu JieJie Microelectronics Co., Ltd ("JJM") reserves the right to amend, correct, modify and enhance the product and/or this document at any time without prior notice. If you intend to purchase this product, please obtain the latest information available before placing your order. The sale of JJM products is governed by JJM's prevailing terms and conditions at the time of purchase and purchasers are solely responsible for the selection and use of the products with no liability on JJM's part to supply application assistance or customization. Purchase of JJM products does not grant the purchaser license, express or implied, to JJM's intellectual property. Any warranties provided with JJM products are null and void upon resale unless accompanied by the information set forth herein in its entirety. The JJM name and logo are registered trademarks of Jiangsu JieJie Microelectronics Co., Ltd. This document supersedes all previous versions. ©2024 JJM - All rights reserved